

Article number: 0105045

Description: Retaining ring AV 28

Note: Fitted with ZGA pliers

Measures

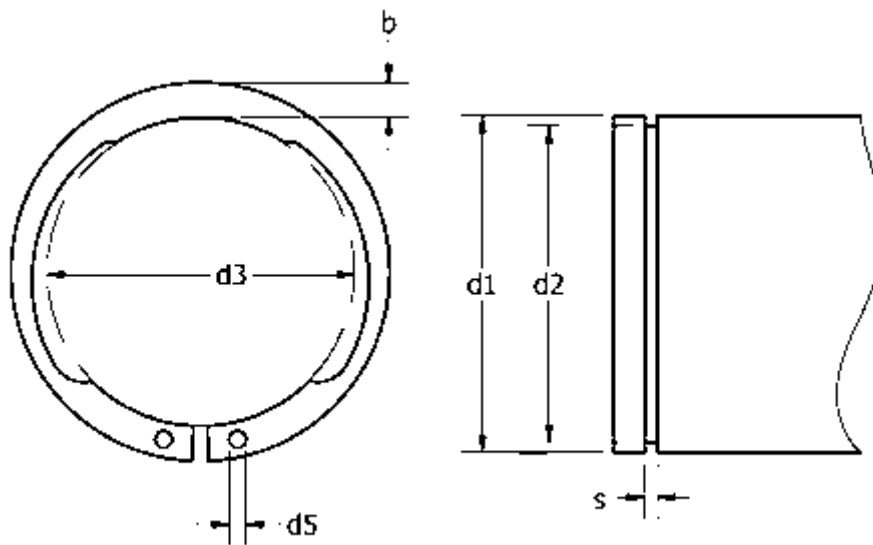

AN mm ²	= 27.0	FRg kN	= 6.4	t	= 0.70
b	= 3.8	FR kN	= 28.0	tol	= -0.06
d1	= 28	g	= 1.5	tol	= -0.21
d2	= 26.6	K kN-mm	= 56.0	tol	= +0,21-0,42
d3	= 25.90	m min	= 1.00	tol	= 0.1
d5 min	= 2.0	n abl x 1000	= 22	Tong	= ZGA-2
Description	= AV 28	s	= 1.50	Weight kg/1000	= 3.18
FN kN	= 4.50	Side power N at I2	= 2.1		